

RayVio XP Series UV LEDs

Highest UV power for disinfection, sterilization and phototherapy

UV Power from the XP Series enables compact, portable, and battery-operated devices that can meet demanding water, air and surface disinfection requirements and deliver professional medical or phototherapy solutions.

RayVio XP Series UV LEDs deliver high-power and high-density UV light with peak spectral wavelength outputs of 280nm and 310nm.



Features and Benefits

- Highest available UV output power in the industry – rated for 70mW from a single package – enables high output and compact applications.
- Industry leading reliability and lifetime.
- Proven germicidal efficacy at 280nm.
- Proven effective for skin treatment at 310nm.
- Footprint includes electrically neutral thermal path, providing excellent thermal properties.
- Industry standard surface mount device (SMD) package enables high volume manufacturing with existing equipment and processes.
- Star board package simplifies thermal engineering and allows for rapid prototyping and development.

Applications

- Water disinfection
- Surface disinfection
- Air disinfection
- Medical devices
- Phototherapy





Table of Contents

Highest UV power for disinfection, sterilization and phototherapy	1
Features and Benefits	1
Applications	1
Table of Contents	2
Product Nomenclature	3
Product Nomenclature Detail	3
Environmental Compliance	3
Product Performance and Characterization	4
Typical Optical Characteristics	4
Typical Electrical Characteristics	5
Reliability	6
Absolute Maximum Ratings	6
Typical Characteristic Curves	7
Mechanical Dimensions Surface Mount	10
Mechanical Dimensions Star Board Mount	11
Soldering Conditions	12
Product Binning and Labeling	13
Purpose of Product Binning	13
Product Bin Label Structure	13
Peak Wavelength, Power Output and Forward Voltage Bins	13
XP Series Parts List	15
Product Labeling	16
Cautions on Use	17
Eye and Skin Safety Guidelines	17
Usage and Handling	17
Cleaning	17
Static Electricity	17
Thermal Management	18
Recommended Circuit	18
About Rayvio	19



Product Nomenclature

Part numbers listed below with part descriptions are used to identify part configuration (subject to change).

Part Number	Part Description
RVXP(n)-280-SM-wwppvv00	280nm nominal wavelength, 60mW power output, surface mount
RVXP(n)-280-SB-wwppvv00	280nm nominal wavelength, 60mW power output, star board mount
RVXP(n)-310-SM-wwppvv00	310nm nominal wavelength, 60mW power output, surface mount
RVXP(n)-310-SB-wwppvv00	310nm nominal wavelength, 60mW power output, star board mount

Other wavelengths are available upon request.

Product Nomenclature Detail

RVXP(n)	280	ff	wwppvv00
↓	↓	↓	↓
RayVio Series Identifier	Typ. Wavelength	Form Factor	Bin Codes
XP1	280	SM – Surface Mount	Peak Wavelength (ww)
XP4	310	SB – Star Board	Power Output (pp)
			Forward Voltage (vv)

Environmental Compliance

RayVio is committed to providing environmentally friendly products to the healthcare and hygiene management marketplace. RayVio is compliant to the European Union directives on the restriction of hazardous substances in electronic equipment, also known as the RoHS directive. RayVio products do not contain the restricted materials: lead, mercury, cadmium, hexavalent chromium, polybrominated biphenyls (PBB) or polybrominated diphenyl ethers (PBDE).

Product Performance and Characterization

Typical Optical Characteristics

Table 1. Radiant Output Performance Characteristics at $T_a=25^\circ\text{C}$

Typical Wavelength (nm)	Part Number	Radiant Output @ 200mA, 25°C			Spectral Width (nm) (FWHM)	Viewing Angle (deg. HM)
		Min. (mW)	Typical (mW)	Max. (mW)		
280	RVXP1-280-ff-wwppvv00	10	16	22	15	120
	RVXP4-280-ff-wwppvv00	30	50	70		

Table 1a. Radiant Output Performance Characteristics at $T_a=25^\circ\text{C}$

Typical Wavelength (nm)	Part Number	Radiant Output @ 200mA, 25°C			Spectral Width (nm) (FWHM)	Viewing Angle (deg. HM)
		Min. (mW)	Typical (mW)	Max. (mW)		
310	RVXP1-310-ff-wwppvv00	10	16	22	15	120
	RVXP4-310-ff-wwppvv00	30	50	70		

Table 2. Peak Wavelength Performance Characteristics at $T_a=25^\circ\text{C}$

Typical Wavelength (nm)	Part Number	Emission Peak Wavelength		
		Min. (nm)	Typical (nm)	Max. (nm)
280	RVXP(n)-280-ff-wwppvv00	275	280	285

Table 2a. Peak Wavelength Performance Characteristics at $T_a=25^\circ\text{C}$

Typical Wavelength (nm)	Part Number	Emission Peak Wavelength		
		Min. (nm)	Typical (nm)	Max. (nm)
310	RVXP(n)-310-ff-wwppvv00	305	310	315

Notes for Tables 1 and 2:

1. Production parts are tested at nominal current of 200mA, 25°C.
2. Tolerances for the optical characteristics are as follows:
 - a. Radiant Output: $\pm 7\%$
 - b. Peak wavelength: $\pm 2\text{nm}$

Typical Electrical Characteristics

Electrical Characteristics of surface mount emitters and star board mounted emitters.

Solder Pad Temperature = 25°C, Test Current = 200mA

Table 3. Forward Voltage and Junction Temperature

Part Number	Forward Voltage V_f			Typical Thermal Resistance Junction to Solder Pad (°C/W)
	Min. V_f	Typical V_f	Max. V_f	
RVXP1-280-SM-wwppvv00	5	6.5	8	8
RVXP1-280-SB-wwppvv00				12
RVXP4-280-SM-wwppvv00	20	26	32	3
RVXP4-280-SB-wwppvv00				4

Table 3a. Forward Voltage and Junction Temperature

Part Number	Forward Voltage V_f			Typical Thermal Resistance Junction to Solder Pad (°C/W)
	Min. V_f	Typical V_f	Max. V_f	
RVXP1-310-SM-wwppvv00	5	6.5	8	8
RVXP1-310-SB-wwppvv00				12
RVXP4-310-SM-wwppvv00	20	26	32	3
RVXP4-310-SB-wwppvv00				4

Notes for Table 3:

1. Measured between $T_j = 25^\circ\text{C}$ and $T_j = 60^\circ\text{C}$.
2. Tolerance for the electrical characteristics are as follows:
 - a. Forward Voltage V_f : $\pm 2\%$
3. Thermal resistance of RVXP(n)-xxx-SB-wwppvv00 is the combined value of LED and star board

Reliability

RayVio conducts ongoing testing of its UV LEDs for reliability to ensure performance over time. Contact a RayVio Account Manager for more detailed information.

Table 4.

Forward Current	% of Nominal Output Power	P70 B50 Reliability
100mA	50%	10,000 hours
150mA	75%	4,444 hours
200mA (nominal)	100% (nominal)	2,500 hours

Absolute Maximum Ratings

Table 5.

Parameter	Maximum Performance
Power Dissipation	1.6W or 6.4W
Forward Current	200mA
Junction Temperature, T_j	80°C
Storage Temperature	-30, 150°C
ESD Sensitivity	+/-8kV Human Body Model

Typical Characteristic Curves

Spectrum 280nm

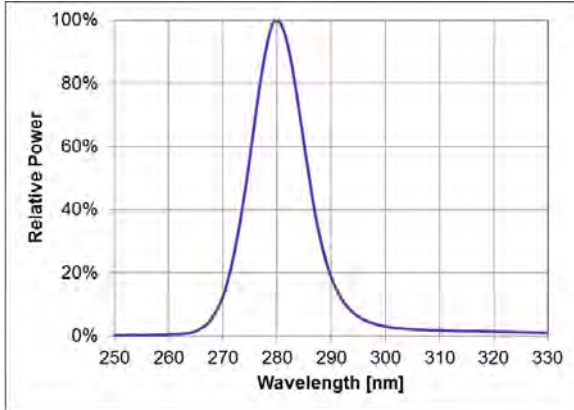

Spectrum 310nm

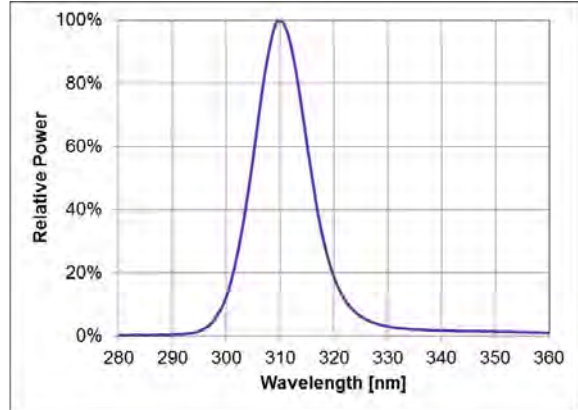

Radiant Power vs. Drive Current

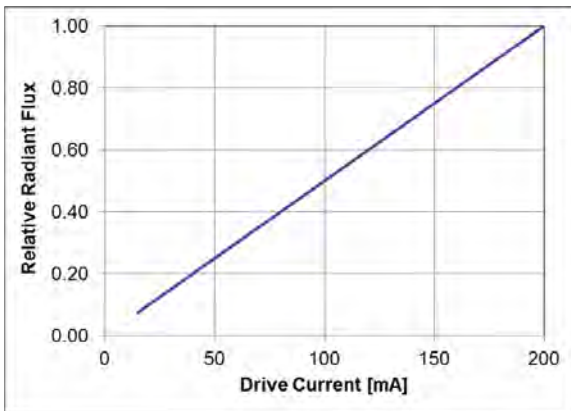

Angular Emission Intensity Distribution

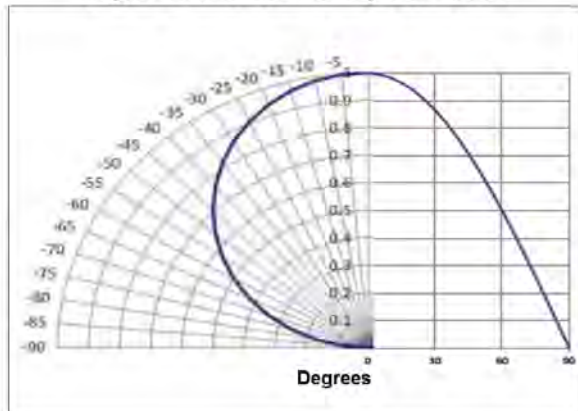

Forward Current vs. Voltage XP1

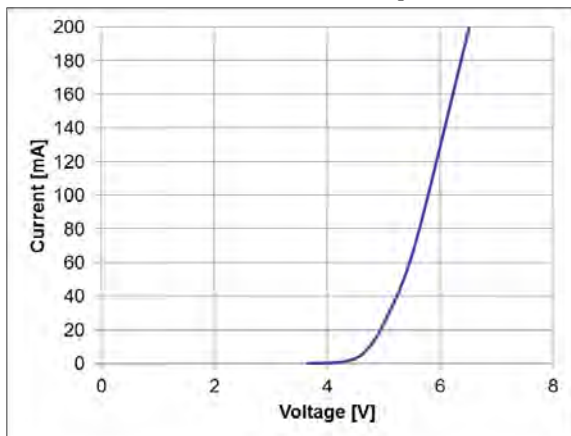

Forward Current vs. Voltage XP4

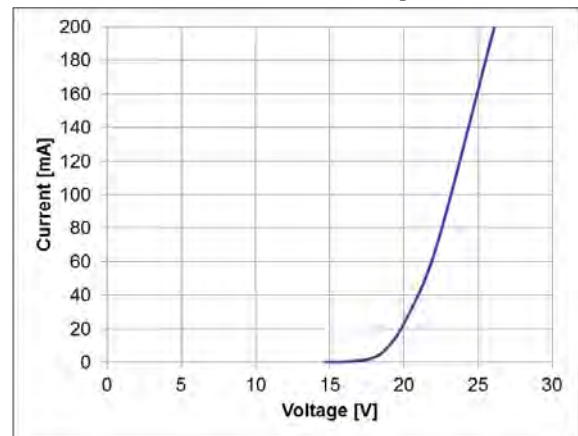

Typical Characteristic Curves (continued)

Radiant Power vs. Temperature

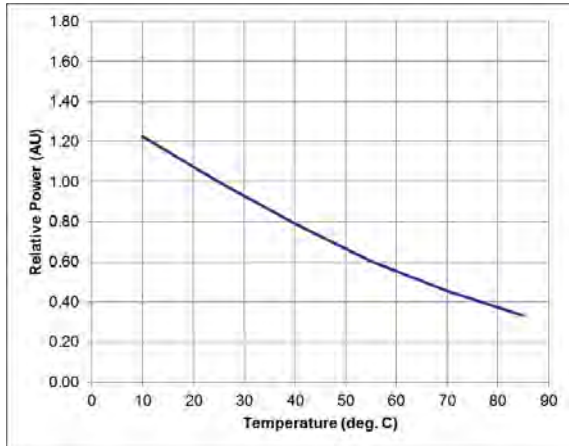

Peak Wavelength vs. Temperature 280nm

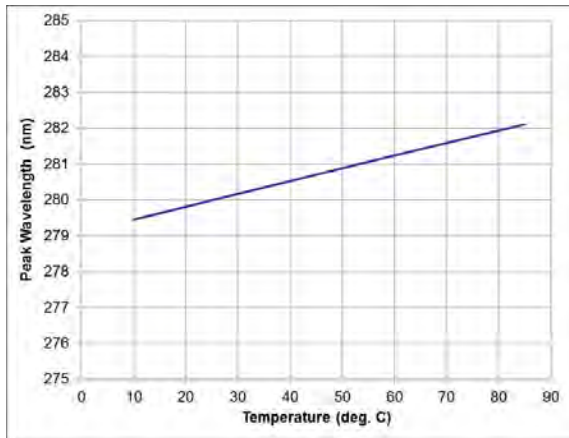

Peak Wavelength vs. Temperature 310nm

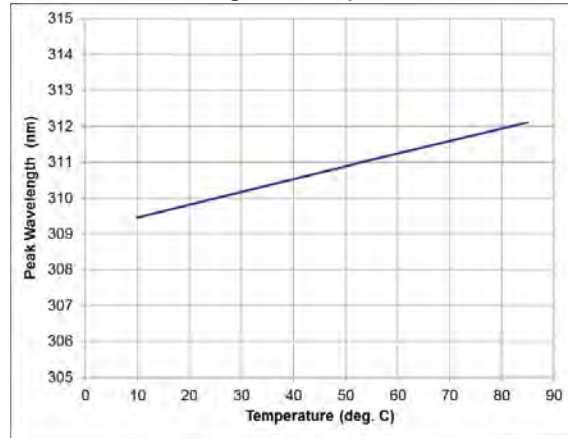

Voltage vs. Temperature XP1

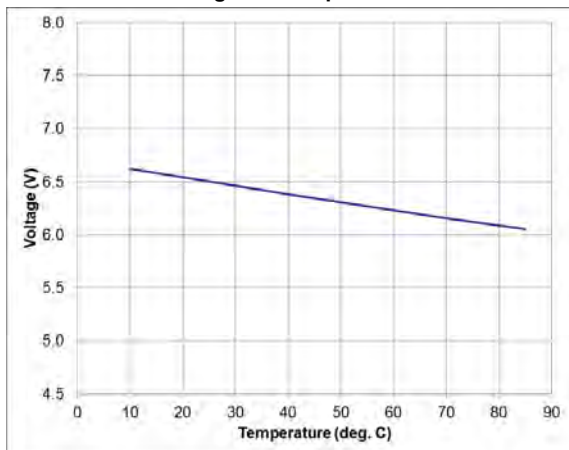

Voltage vs. Temperature XP4

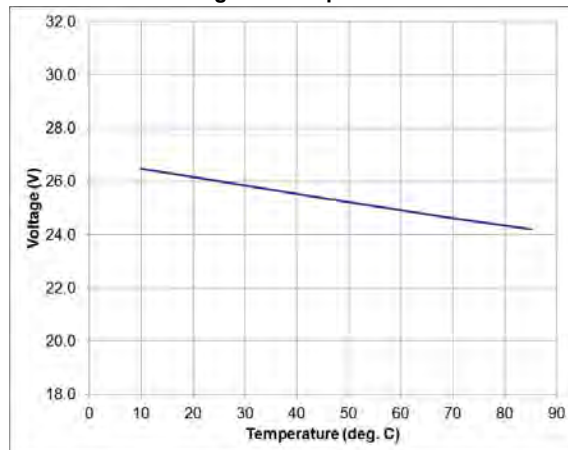

Typical Characteristic Curves (continued)

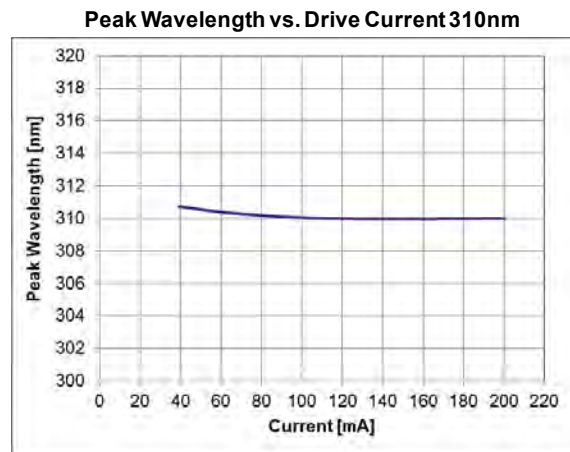
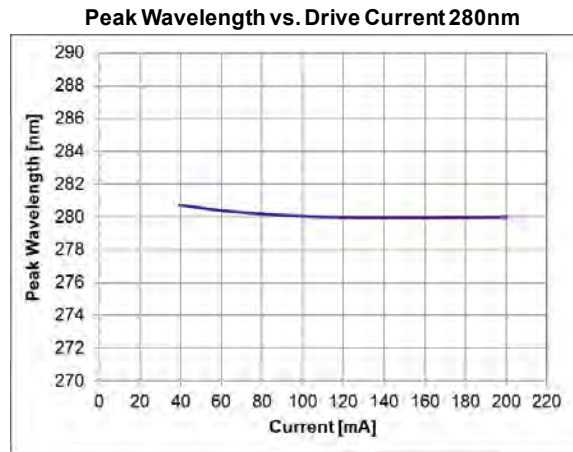

Mechanical Dimensions Surface Mount

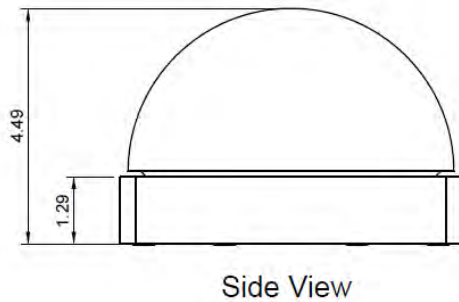
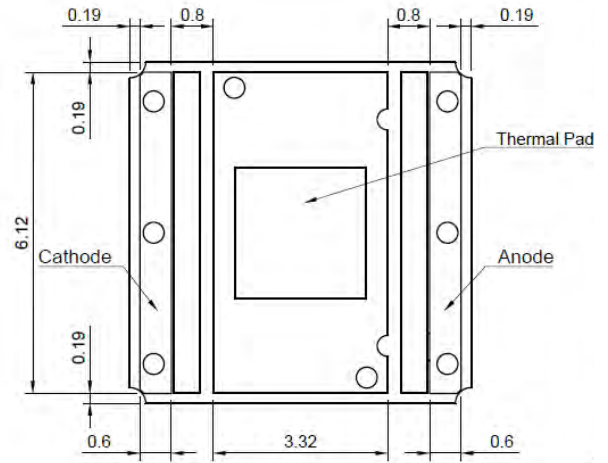
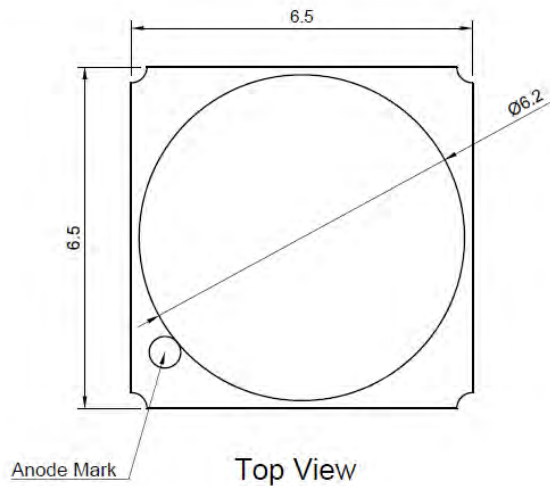

Notes:

1. All measurements in millimeters.
2. Tolerances $\pm 0.1\text{mm}$

Mechanical Dimensions Star Board Mount

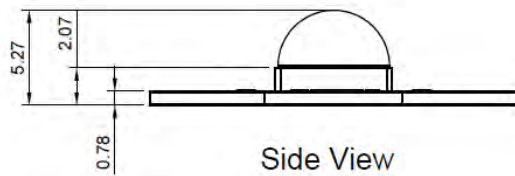
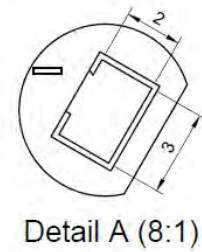
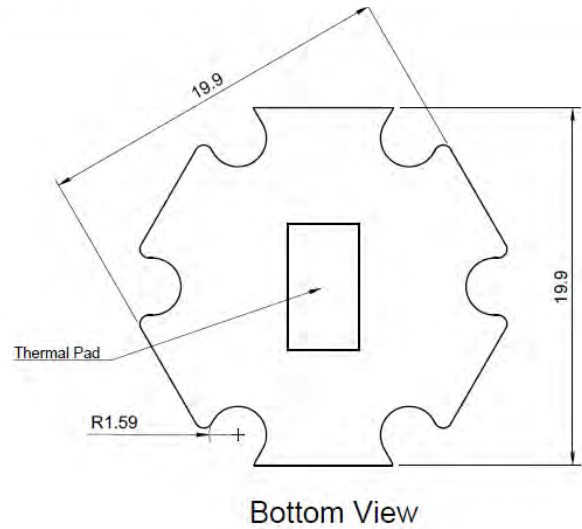
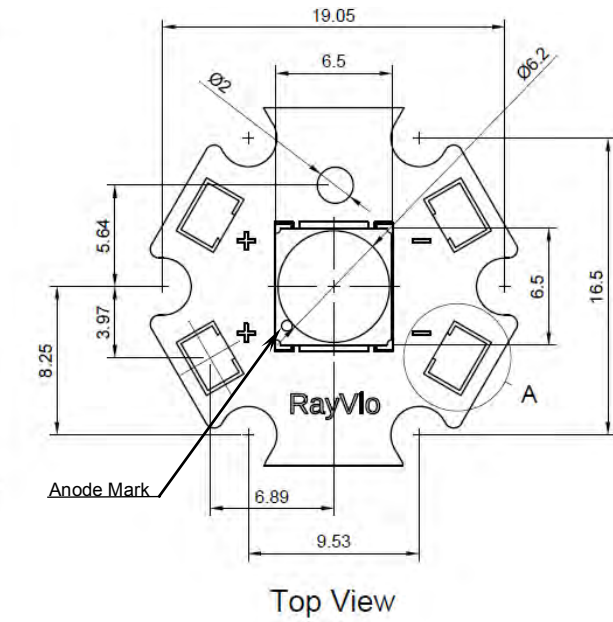

Notes:

1. All measurements in millimeters.
2. Tolerances $\pm 0.1\text{mm}$

Soldering Conditions

Reflow soldering is the recommended method for assembling LEDs on a circuit board.

Recommended Soldering Profile (according to JEDEC J-STD-020D)

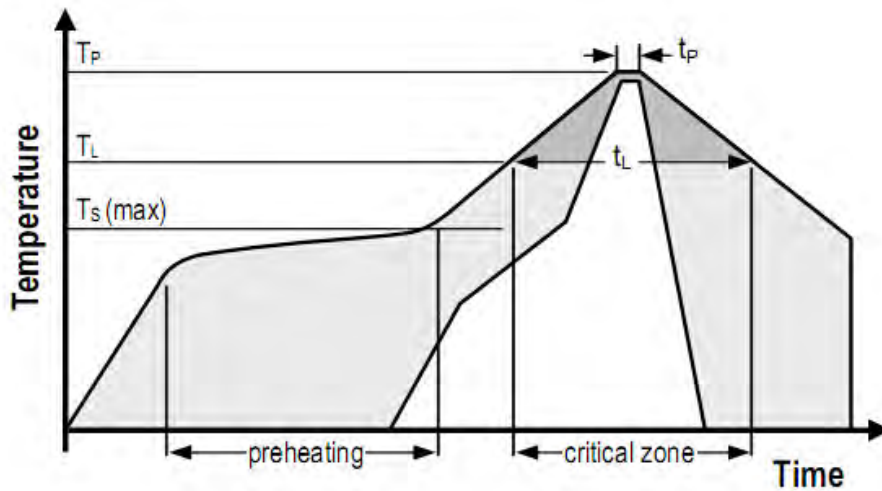

Table 6.

Profile Parameters	Lead-Free Solder
Average Ramp-Up Rate ($T_{s,max}$ to T_p)	3°C/second max.
Preheat: Temperature Min ($T_{s,min}$)	150°C
Preheat: Temperature Max ($T_{s,max}$)	200°C
Preheat: Time ($t_{s,min}$ to $t_{s,max}$)	60-120 seconds
Time Maintained Above: Temperature (T_L)	217°C
Time Maintained Above: Time (t_L)	60-150 seconds
Peak/Classification Temperature (T_p)	250°C
Time Within 5°C of Actual Peak Temperature (t_p)	30 seconds
Ramp-Down Rate	6°C/second max
Time 25°C to Peak Temperature	8 minutes max.

Reflow soldering should not be done more than two times.

Product Binning and Labeling

Purpose of Product Binning

In the manufacturing process, the products described here are produced in a distribution around the typical performance values listed. RayVio sorts and labels products into bins according to output power, peak wavelength and forward voltage.

Product Bin Label Structure

All emitters packaged together are sorted to the same bin(s). The bin code label is comprised of the last 8-digits of the part number and is included on the printed label. Combinations of various bins may be used to optimize the consistency of the application.

The bin code labels follow the alphanumeric code structure below.

- wwppv00
- ww = peak wavelength bin
- pp = power output bin
- vv = V_f bin

Peak Wavelength, Power Output and Forward Voltage Bins

Tables 5, 6 and 7 list the standard functional bins for RayVio emitters (tested and binned at 200mA, 25°C). Although several bins are outlined, product availability in a particular bin varies by production run and by product performance. Contact RayVio for specific bin availability.

Table 7. Peak Wavelength Bins

For Part Numbers	Bin Code (ww)	Minimum Peak Wavelength (nm)	Maximum Peak Wavelength (nm)
RVXP(n)-280-ff-wwppv00	07	275	285
RVXP(n)-310-ff-wwppv00	19	305	315

Table 8. Power Output Bins

For Part Numbers	Bin Code (pp)	Minimum Power Output (mW)	Maximum Power Output (mW)
RVXP1-280-ff-wwppvv00 RVXP1-310-ff-wwppvv00	49	10	14
	54	14	18
	57	18	24
RVXP4-280-ff-wwppvv00 RVXP4-310-ff-wwppvv00	62	30	40
	65	40	50
	68	50	60
	71	60	70

Table 9. Forward Voltage Bins

For Part Numbers	Bin Code (vv)	Minimum Forward Voltage (V _f)	Maximum Forward Voltage (V _f)
RVXP1-280-ff-wwppvv00 RVXP1-310-ff-wwppvv00	08	5	8
RVXP4-280-ff-wwppvv00 RVXP4-310-ff-wwppvv00	32	20	32

XP Series Parts List

Table 10. XP Series Part Number Combinations

Part Number	Typical Wavelength	Minimum Output	Typical Forward Voltage
RVXP1-280-SM-07490800	280nm	10mW	6.5V
RVXP1-280-SM-07540800	280nm	14mW	6.5V
RVXP1-280-SM-07570800	280nm	18mW	6.5V
RVXP4-280-SM-07623200	280nm	30mW	26V
RVXP4-280-SM-07653200	280nm	40mW	26V
RVXP4-280-SM-07683200	280nm	50mW	26V
RVXP4-280-SM-07713200	280nm	60mW	26V
RVXP1-280-SB-07490800	280nm	10mW	6.5V
RVXP1-280-SB-07540800	280nm	14mW	6.5V
RVXP1-280-SB-07570800	280nm	18mW	6.5V
RVXP4-280-SB-07623200	280nm	30mW	26V
RVXP4-280-SB-07653200	280nm	40mW	26V
RVXP4-280-SB-07683200	280nm	50mW	26V
RVXP4-280-SB-07713200	280nm	60mW	26V
RVXP1-310-SM-19490800	310nm	10mW	6.5V
RVXP1-310-SM-19540800	310nm	14mW	6.5V
RVXP1-310-SM-19570800	310nm	18mW	6.5V
RVXP4-310-SM-19623200	310nm	30mW	26V
RVXP4-310-SM-19653200	310nm	40mW	26V
RVXP4-310-SM-19683200	310nm	50mW	26V
RVXP4-310-SM-19713200	310nm	60mW	26V
RVXP1-310-SB-19490800	310nm	10mW	6.5V
RVXP1-310-SB-19540800	310nm	14mW	6.5V
RVXP1-310-SB-19570800	310nm	18mW	6.5V
RVXP4-310-SB-19623200	310nm	30mW	26V
RVXP4-310-SB-19653200	310nm	40mW	26V
RVXP4-310-SB-19683200	310nm	50mW	26V
RVXP4-310-SB-19713200	310nm	60mW	26V

Product Labeling

Label A

Specifying Part Number, Quantity and Lot Number



Cautions on Use

Eye and Skin Safety Guidelines

Do not directly look at the light when the LEDs are on. Proceed with caution to avoid the risk of damage to the eyes when examining the LEDs with optical instruments. Protect your eyes and skin when operating. Equipment should be designed to completely screen or filter UV radiation.

The attached label should be used on products and systems that use UV LEDs.



Usage and Handling

1. LEDs should be kept away at all times from volatile organic compounds as well as hazardous, acidic, and corrosive substances, such as sulfur, chlorine, hydrofluoric acid, etc. Failure from doing so may result in mechanical degradation of the LED package and/or decrease in electrical and optical performance.
2. Exposure to sudden temperature changes or high humidity level should be avoided.
3. Excessive mechanical force or vibration must be avoided.
4. Extreme care must be observed when handling the LEDs:
 - a) Do not touch the component with bare hands to avoid contamination.
 - b) Do not touch the optical window and/or lens of the LED package with sharp tools, such as tweezers, to avoid scratches.
 - c) To minimize dust accumulation on the optical windows, place LEDs back into the container after usage during storage.
5. Only apply forward electrical current to the LEDs within the specification. Overdriving LEDs or applying reverse current may cause damage to the device.

Cleaning

1. Do not scrub the LEDs using hard brush or with excessive force.
2. Do not clean LEDs using acetone or trichloroethylene.
3. To clean LEDs, only use soft foam-tip cleanroom swab and isopropyl alcohol with gentle cleaning motions. Distilled water can be used for rinsing, but LEDs must be completely dried (for example with nitrogen blow dry) before they can be used.
4. Electrical and optical measurements are recommended before and after cleaning to ensure that LEDs are not damaged.

Static Electricity

Wristbands and anti-electrostatic gloves are strongly recommended and all devices, equipment and machinery must be properly grounded when handling the LEDs, which are sensitive to static electricity. Precautions should be taken against surge voltage to the equipment that mounts the LEDs. Unusual characteristics such as significant increase of current leakage, decrease of turn-on voltage, or non-operation at a low current can occur when the LED is damaged.

Thermal Management

1. Careful design of thermal management system is required for optimal performance of the LEDs.
2. It is recommended that the Starboards are screwed down on a clean and flat heat sink or fixture. Thermal grease may be used for better thermal contact. Soldering Starboards onto a fixture is not recommended.
3. Air- or water-cooled system may be used in conjunction with the heat sink.
4. The thermal management system must be designed such that the LED temperature doesn't surpass the maximum junction temperature.

Recommended Circuit

Operation in series mode:

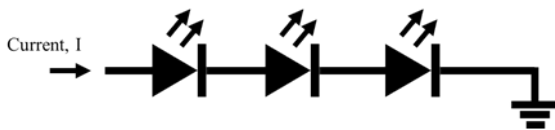

Recommended operation in parallel mode:

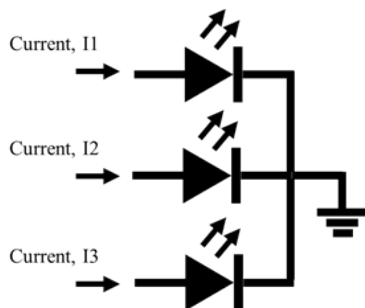



About Rayvio

RayVio Corp. is an advanced health and hygiene company that delivers clean water and environments. RayVio helps protect billions from germs and creates new markets and revenue streams by enabling a new class of products. Its powerful and efficient UV LED technology can be integrated into a variety of applications, powering versatile on-demand solutions that give consumers control over health without chemicals or costly consumables. To learn more, please visit www.rayvio.com.