

RayVio XE Series UV LEDs

Medium UV power density in an easy to use format

Offering highly effective distributed UV light, RayVio's XE Series delivers the broadest range of output options. The advanced XE Series technology enables battery operation for compact and portable applications that serve consumer and professional markets.

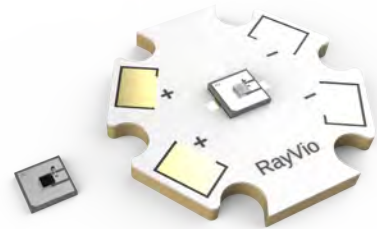

Features and Benefits

- Proven germicidal efficacy at 280nm.
- Proven effective for skin treatment at 310nm.
- Industry leading reliability and lifetime.
- Portable and compact personal applications are more easily realized because of the XE Series' small size and higher power output.
- Industry standard 3535 surface mount package enables high volume manufacturing with existing equipment and processes.
- Footprint includes an electrically neutral solder path for improved heatsinking.
- Star board package simplifies thermal engineering and allows for rapid prototyping and development.

Applications

- Personal hygiene
- Portable devices
- Water disinfection
- Surface disinfection
- Air disinfection
- Phototherapy





Table of Contents

Medium UV power density in an easy to use format	1
Features and Benefits	1
Applications	1
Table of Contents	2
Product Nomenclature	3
Product Nomenclature Detail	3
Environmental Compliance	3
Product Performance and Characterization	4
Typical Optical Characteristics	4
Typical Electrical Characteristics	5
Absolute Maximum Ratings	5
Reliability	5
Typical Characteristic Curves	6
Mechanical Dimensions Surface Mount.....	8
Mechanical Dimensions Star Board Mount	9
Soldering Conditions	10
Product Binning and Labeling	11
Purpose of Product Binning	11
Product Bin Label Structure	11
Peak Wavelength, Power Output and Forward Voltage Bins	11
XE Series Parts List	13
Product Labeling	13
Cautions on Use	14
Eye and Skin Safety Guidelines	14
Usage and Handling	14
Cleaning	14
Static Electricity	14
Thermal Management	15
Recommended Circuit	15
About Rayvio	16



Product Nomenclature

Part numbers listed below with part descriptions are used to identify part configuration (subject to change)

Part Number	Part Description
RVXE-280-SM-wwppvv00	280nm nominal wavelength, up to 6mW power output, surface mount
RVXE-280-SB-wwppvv00	280nm nominal wavelength, up to 6mW power output, star board mount
RVXE-310-SM-wwppvv00	310nm nominal wavelength, up to 6mW power output, surface mount
RVXE-310-SB-wwppvv00	310nm nominal wavelength, up to 6mW power output, star board mount

Other wavelengths are available upon request.

Product Nomenclature Detail

RVXE	280	ff	wwppvv00
RayVio Series Identifier	Typ. Wavelength	Form Factor	Bin Codes
XE	280	SM – Surface Mount	Peak Wavelength (ww)
	310	SB – Star Board	Power Output (pp)
			Forward Voltage (vv)

Environmental Compliance

RayVio is committed to providing environmentally friendly products to the healthcare and hygiene management marketplace. RayVio is compliant to the European Union directives on the restriction of hazardous substances in electronic equipment, also known as the RoHS directive. RayVio products do not contain the restricted materials: lead, mercury, cadmium, hexavalent chromium, polybrominated biphenyls (PBB) or polybrominated diphenyl ethers (PBDE).

Product Performance and Characterization

Typical Optical Characteristics

Table 1. Radiant Output Performance Characteristics at $T_a = 25^\circ\text{C}$

Typical Wavelength (nm)	Part Number	Radiant Output @ 150mA, 25°C			Spectral Width (nm) (FWHM)	Viewing Angle (deg. HM)
		Min. (mW)	Typical (mW)	Max. (mW)		
280	RVXE-280-SM-wwppvv00	1.5	4	6	15	120
	RVXE-280-SB-wwppvv00					

Table 1a. Radiant Output Performance Characteristics at $T_a = 25^\circ\text{C}$

Typical Wavelength (nm)	Part Number	Radiant Output @ 150mA, 25°C			Spectral Width (nm) (FWHM)	Viewing Angle (deg. HM)
		Min. (mW)	Typical (mW)	Max. (mW)		
310	RVXE-310-SM-wwppvv00	1.5	4	6	15	120
	RVXE-310-SB-wwppvv00					

Table 2. Peak Wavelength Performance Characteristics at $T_a = 25^\circ\text{C}$

Typical Wavelength (nm)	Part Number	Emission Peak Wavelength		
		Min. (nm)	Typical (nm)	Max. (nm)
280	RVXE-280-SM-wwppvv00	275	280	285
	RVXE-280-SB-wwppvv00			

Table 2a. Peak Wavelength Performance Characteristics at $T_a = 25^\circ\text{C}$

Typical Wavelength (nm)	Part Number	Emission Peak Wavelength		
		Min. (nm)	Typical (nm)	Max. (nm)
310	RVXE-310-SM-wwppvv00	305	310	315
	RVXE-310-SB-wwppvv00			

Notes for Tables 1 and 2:

1. Production parts are tested at nominal current of 150mA, 25°C.
2. Tolerances for the optical characteristics are as follows:
 - a. Radiant Output: $\pm 7\%$
 - b. Peak wavelength: $\pm 2\text{nm}$

Typical Electrical Characteristics

Electrical Characteristics of surface mount emitters and star board mounted emitters.

Solder Pad Temperature = 25°C, Test Current = 150mA

Table 3. Forward Voltage and Junction Temperature

Part Number	Forward Voltage V_f			Typical Thermal Resistance Junction to Solder Pad (°C/W)
	Min. V_f	Typical V_f	Max. V_f	
RVXE-280-SM-wwppvv00	5	6.5	8	7
RVXE-280-SB-wwppvv00				12
RVXE-310-SM-wwppvv00	5	6.5	8	7
RVXE-310-SB-wwppvv00				12

Notes for Table 3:

1. Measured between $T_j = 25^\circ\text{C}$ and $T_j = 60^\circ\text{C}$.
2. Tolerance for the electrical characteristics are as follows:
 - a. Forward Voltage V_f : $\pm 2\%$
3. Thermal resistance of RVXE-xxx-SB-ppvv00 is the combined value of LED and the heat sink (star board)

Absolute Maximum Ratings

Table 4.

Parameter	Maximum Performance
Power Dissipation	1.6W
Forward Current	200mA
Junction Temperature, T_j	80°C
Storage Temperature	-30, 150°C
ESD Sensitivity	+/-8kV

Reliability

RayVio conducts ongoing testing of its UV LEDs for reliability to ensure performance over time. Contact a RayVio Account Manager for more detailed information.

Table 5.

Forward Current	% of Nominal Output Power	P70 B50 Reliability
75mA	50%	8,000 hours
150mA (nominal)	100% (nominal)	2,000 hours
200mA	133%	1,125 hours

Typical Characteristic Curves

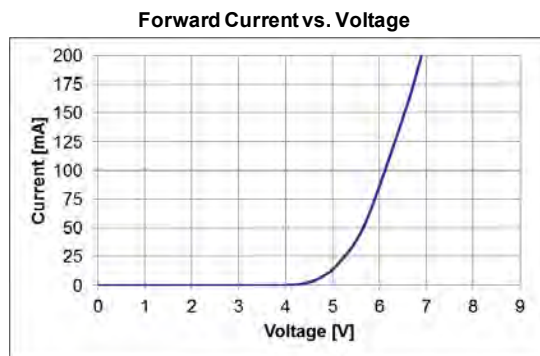
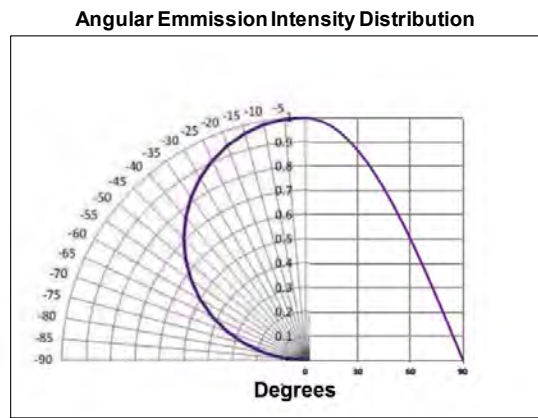
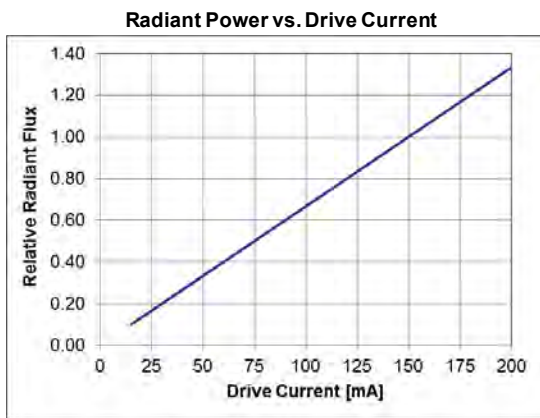
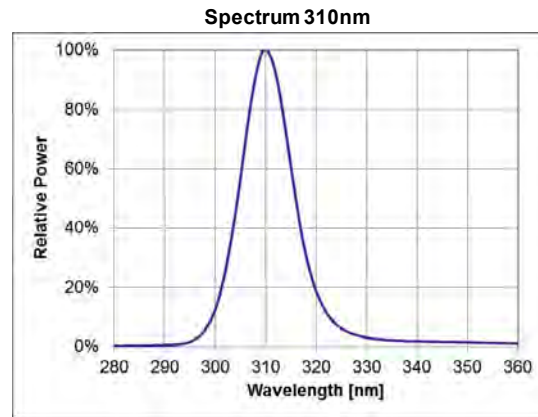
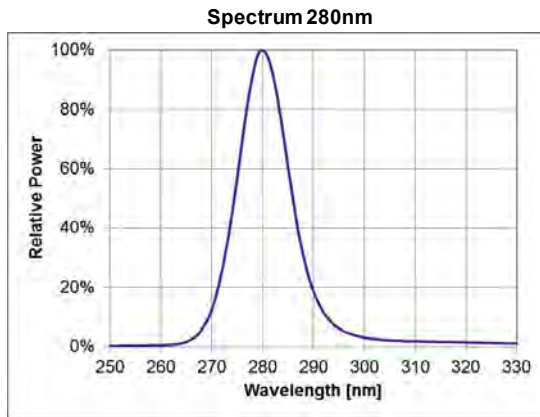

Typical Characteristic Curves (continued)

Radiant Power vs. Temperature

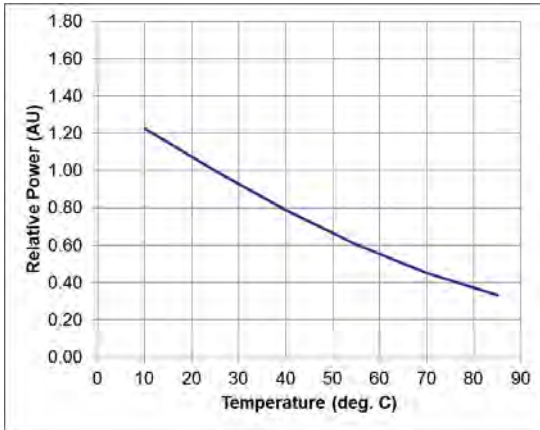

Voltage vs. Temperature

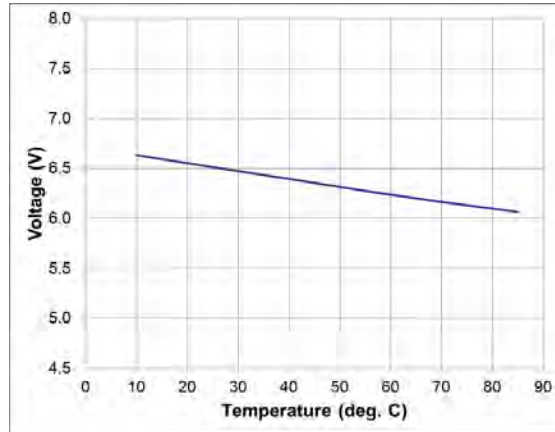

Peak Wavelength vs. Temperature 280nm

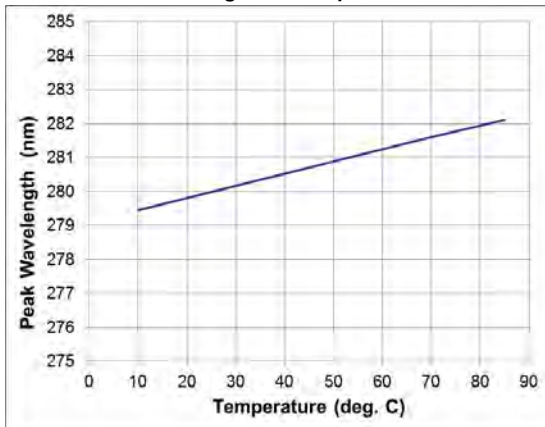

Peak Wavelength vs. Temperature 310nm

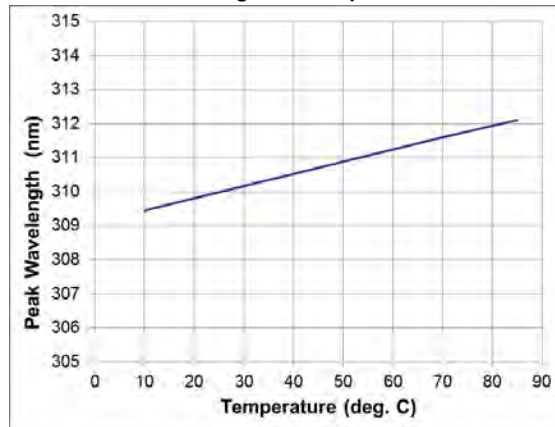

Peak Wavelength vs. Drive Current 280nm

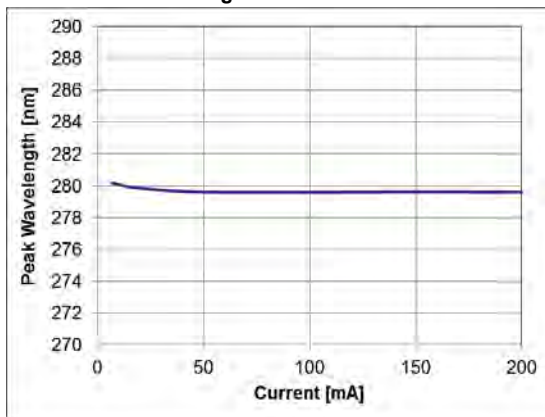

Peak Wavelength vs. Drive Current 310nm

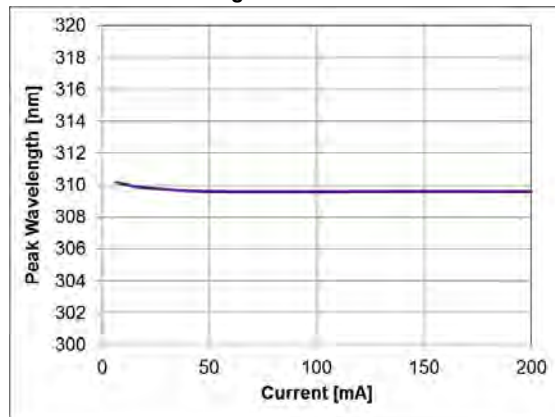

Mechanical Dimensions Surface Mount

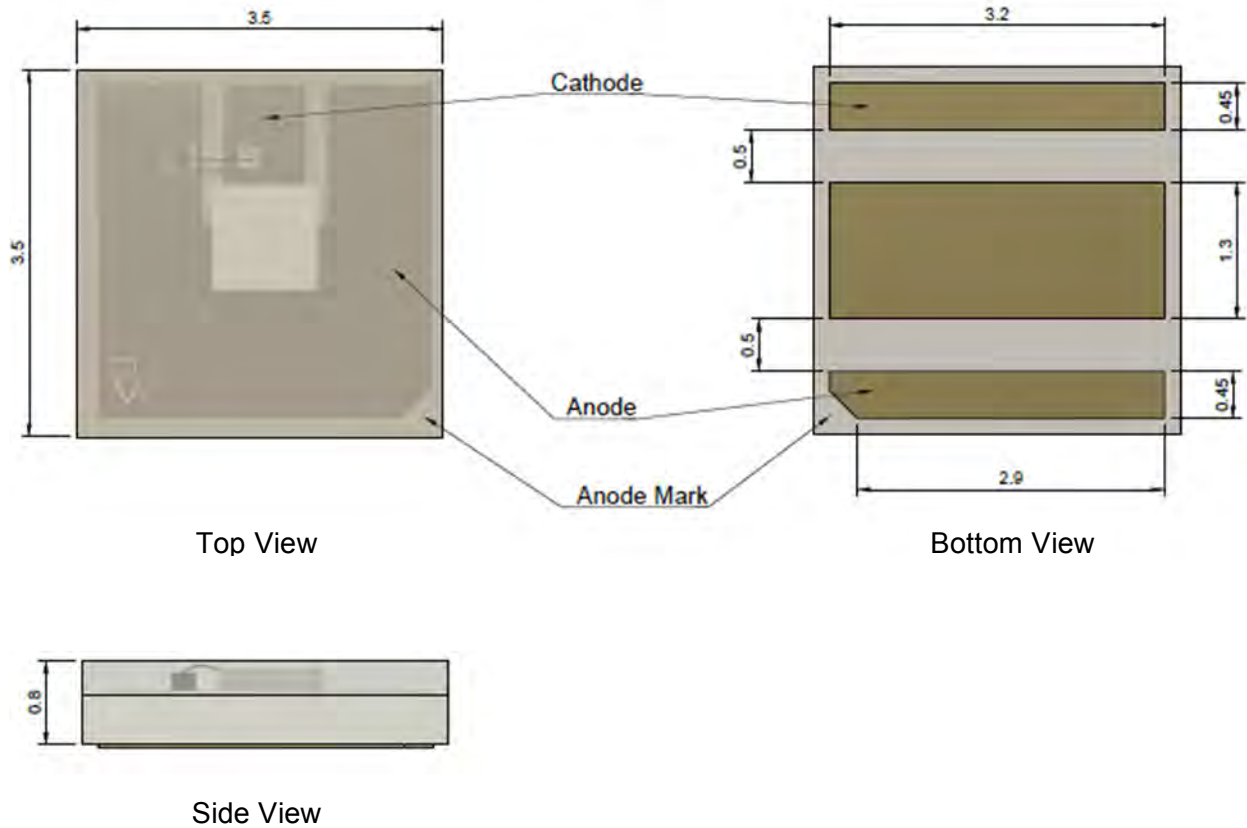

Notes:

1. All measurements in millimeters.
2. Tolerances $\pm 0.1\text{mm}$.

Mechanical Dimensions Star Board Mount

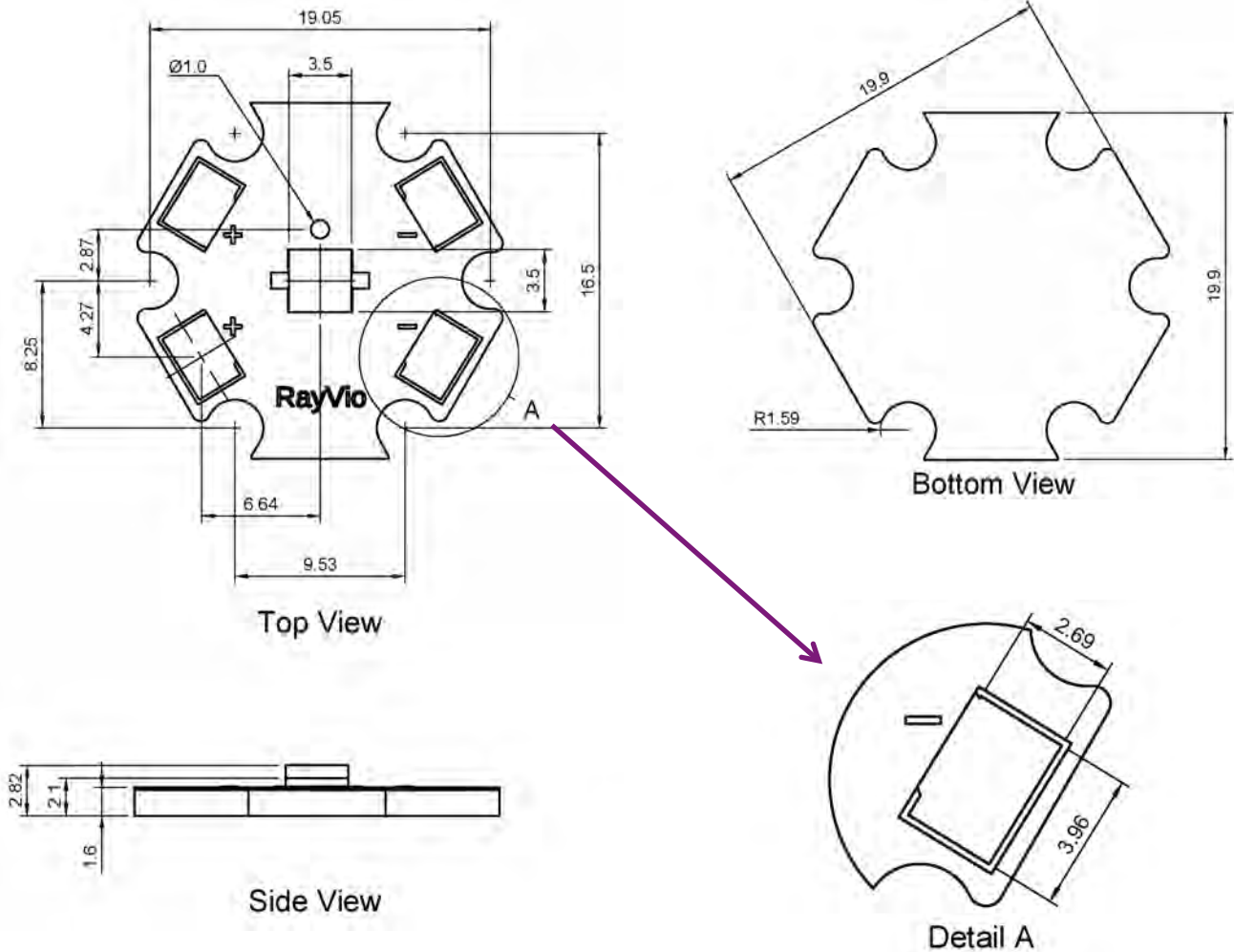

Notes:

1. All measurements in millimeters.
2. Tolerances $\pm 0.1\text{mm}$.

Soldering Conditions

Reflow soldering is the recommended method for assembling LEDs on a circuit board.

Recommended Soldering Profile (according to JEDEC J-STD-020D)

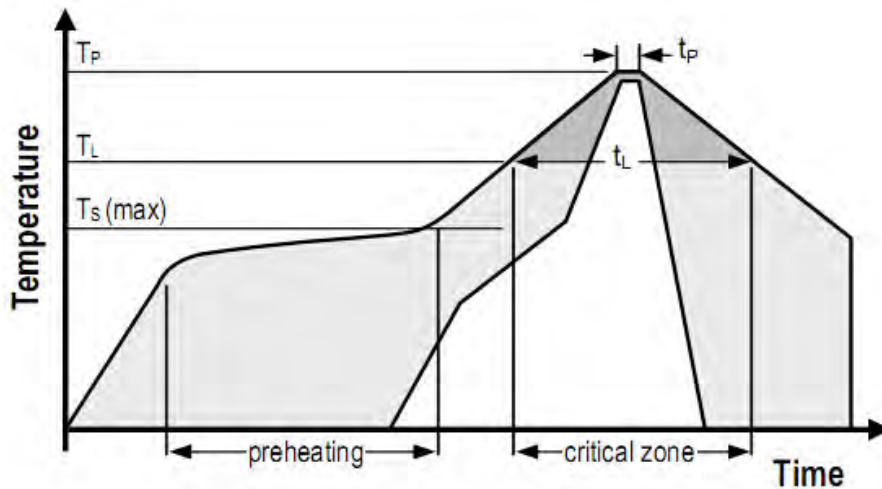

Profile Parameters	Lead-Free Solder
Average Ramp-Up Rate ($T_{s\max}$ to T_p)	3°C/second max.
Preheat: Temperature Min ($T_{s\min}$)	150°C
Preheat: Temperature Max ($T_{s\max}$)	200°C
Preheat: Time ($t_{s\min}$ to $t_{s\max}$)	60-120 seconds
Time Maintained Above: Temperature (T_L)	217°C
Time Maintained Above: Time (t_L)	60-150 seconds
Peak/Classification Temperature (T_p)	250°C
Time Within 5°C of Actual Peak Temperature (t_p)	30 seconds
Ramp-Down Rate	6°C/second max
Time 25°C to Peak Temperature	8 minutes max.

Reflow soldering should not be done more than two times.

Product Binning and Labeling

Purpose of Product Binning

In the manufacturing process, the products described here are produced in a distribution around the typical performance values listed. RayVio sorts and labels products into bins according to output power, peak wavelength and forward voltage.

Product Bin Label Structure

All emitters packaged together are sorted to the same bin(s). The bin code label is comprised of the last 8-digits of the part number and is included on the printed label. Combinations of various bins may be used to optimize the consistency of the application.

The bin code labels follow the alphanumeric code structure below

wwppvv00

- ww = peak wavelength bin
- pp = power output bin
- vv = V_f bin

Peak Wavelength, Power Output and Forward Voltage Bins

Tables 5, 6 and 7 list the standard functional bins for RayVio emitters (tested and binned at 150mA, 25°C). Although several bins are outlined, product availability in a particular bin varies by production run and by product performance. Contact RayVio for specific bin availability.

Table 5. Peak Wavelength Bins

For Part Numbers	Bin Code (ww)	Minimum Peak Wavelength (nm)	Maximum Peak Wavelength (nm)
RVXE-280-SM-wwppvv00 RVXE-280-SB-wwppvv00	07	275	285
RVXE-310-SM-wwppvv00 RVXE-310-SB-wwppvv00	19	305	315

Table 6. Power Output Bins

For Part Numbers	Bin Code (pp)	Minimum Power Output (mW)	Maximum Power Output (mW)
RVXE-280-SM-wwppvv00 RVXE-280-SB-wwppvv00	10	1.5	2.5
RVXE-310-SM-wwppvv00 RVXE-310-SB-wwppvv00	15	2.5	4
RVXE-310-SB-wwppvv00	26	4	6

Table 7. Forward Voltage Bins

For Part Numbers	Bin Code (vv)	Minimum Forward Voltage (V _f)	Maximum Forward Voltage (V _f)
RVXE-280-SM-wwppvv00 RVXE-280-SB-wwppvv00 RVXE-310-SM-wwppvv00 RVXE-310-SB-wwppvv00	04	5	8

XE Series Parts List

Table 8. XE Series Part Number Combinations

Part Number	Typical Wavelength	Minimum Output	Typical Forward Voltage
RVXE-280-SM-07100400	280nm	1.5mW	6.5
RVXE-280-SM-07150400	280nm	2.5mW	6.5
RVXE-280-SM-07260400	280nm	4mW	6.5
RVXE-280-SB-07100400	280nm	1.5mW	6.5
RVXE-280-SB-07150400	280nm	2.5mW	6.5
RVXE-280-SB-07260400	280nm	4mW	6.5
RVXE-310-SM-19100400	310nm	1.5mW	6.5
RVXE-310-SM-19150400	310nm	2.5mW	6.5
RVXE-310-SM-19260400	310nm	4mW	6.5
RVXE-310-SB-19100400	310nm	1.5mW	6.5
RVXE-310-SB-19150400	310nm	2.5mW	6.5
RVXE-310-SB-19260400	310nm	4mW	6.5

Product Labeling

Label A

Specifying Part Number, Quantity and Lot Number

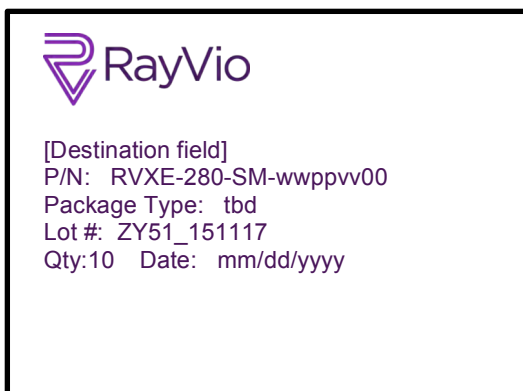

Cautions on Use

Eye and Skin Safety Guidelines

Do not directly look at the light when the LEDs are on. Proceed with caution to avoid the risk of damage to the eyes when examining the LEDs with optical instruments. Protect your eyes and skin when operating. Equipment should be designed to completely screen or filter UV radiation.

The attached label should be used on products and systems that use UV LEDs.

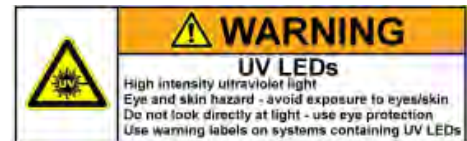

Usage and Handling

1. LEDs should be kept away at all times from volatile organic compounds as well as hazardous, acidic, and corrosive substances, such as sulfur, chlorine, hydrofluoric acid, etc. Failure from doing so may result in mechanical degradation of the LED package and/or decrease in electrical and optical performance.
2. Exposure to sudden temperature changes or high humidity level should be avoided.
3. Excessive mechanical force or vibration must be avoided.
4. Extreme care must be observed when handling the LEDs:
 - a) Do not touch the component with bare hands to avoid contamination.
 - b) Do not touch the optical window and/or lens of the LED package with sharp tools, such as tweezers, to avoid scratches.
 - c) To minimize dust accumulation on the optical windows, place LEDs back into the container after usage during storage.
5. Only apply forward electrical current to the LEDs within the specification. Overdriving LEDs or applying reverse current may cause damage to the device.

Cleaning

1. Do not scrub the LEDs using hard brush or with excessive force.
2. Do not clean LEDs using acetone or trichloroethylene.
3. To clean LEDs, only use soft foam-tip cleanroom swab and isopropyl alcohol with gentle cleaning motions. Distilled water can be used for rinsing, but LEDs must be completely dried (for example with nitrogen blow dry) before they can be used.
4. Electrical and optical measurements are recommended before and after cleaning to ensure that LEDs are not damaged.

Static Electricity

Wristbands and anti-electrostatic gloves are strongly recommended and all devices, equipment and machinery must be properly grounded when handling the LEDs, which are sensitive to static electricity. Precautions should be taken against surge voltage to the equipment that mounts the LEDs. Unusual characteristics such as significant increase of current leakage, decrease of turn-on voltage, or non-operation at a low current can occur when the LED is damaged.

Thermal Management

1. Careful design of thermal management system is required for optimal performance of the LEDs.
2. It is recommended that the Starboards are screwed down on a clean and flat heat sink or fixture. Thermal grease may be used for better thermal contact. Soldering Starboards onto a fixture is not recommended.
3. Air- or water-cooled system may be used in conjunction with the heat sink.
4. The thermal management system must be designed such that the LED temperature doesn't surpass the maximum junction temperature.

Recommended Circuit

Operation in series mode:

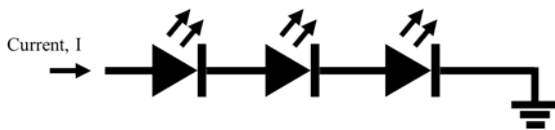

Recommended operation in parallel mode:

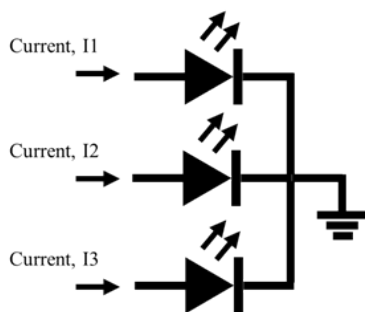



About Rayvio

RayVio Corp. is an advanced health and hygiene company that delivers clean water and environments. RayVio helps protect billions from germs and creates new markets and revenue streams by enabling a new class of products. Its powerful and efficient UV LED technology can be integrated into a variety of applications, powering versatile on-demand solutions that give consumers control over health without chemicals or costly consumables. To learn more, please visit www.rayvio.com.